

Справ. №

Перв. примен.

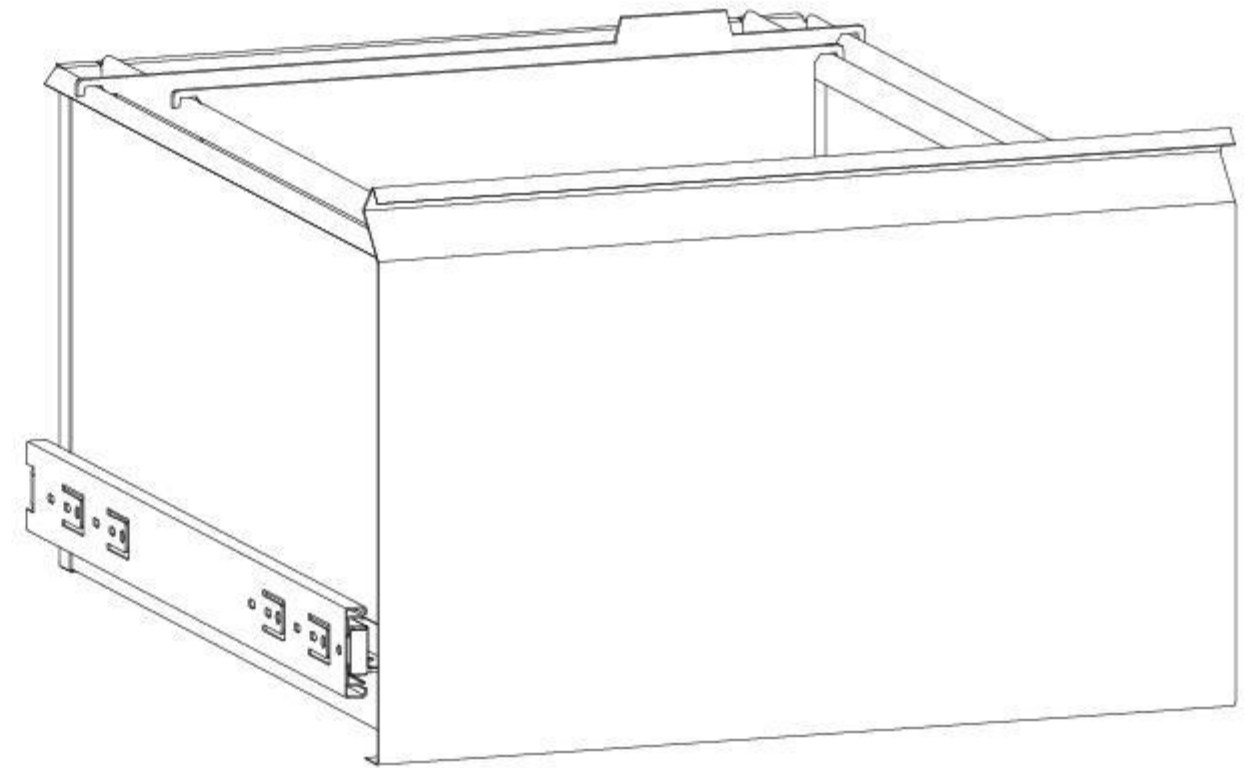
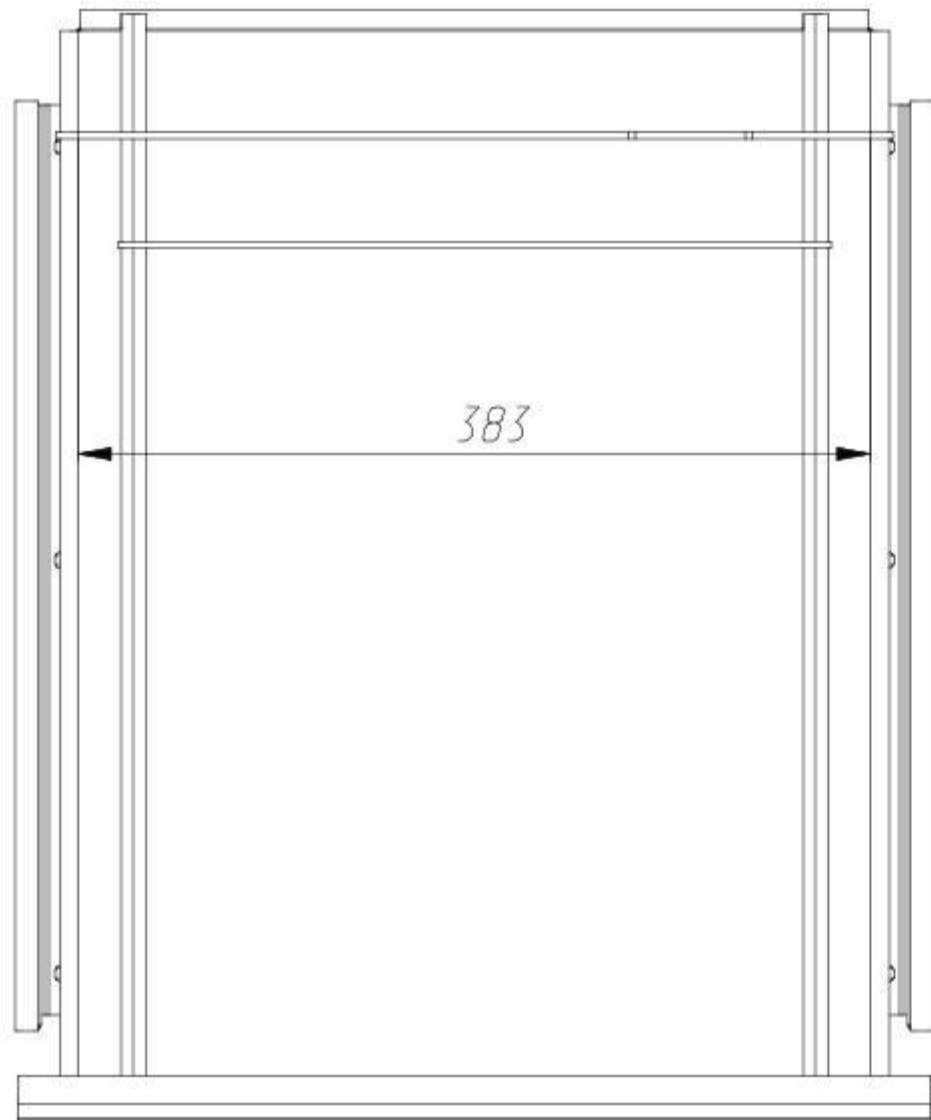
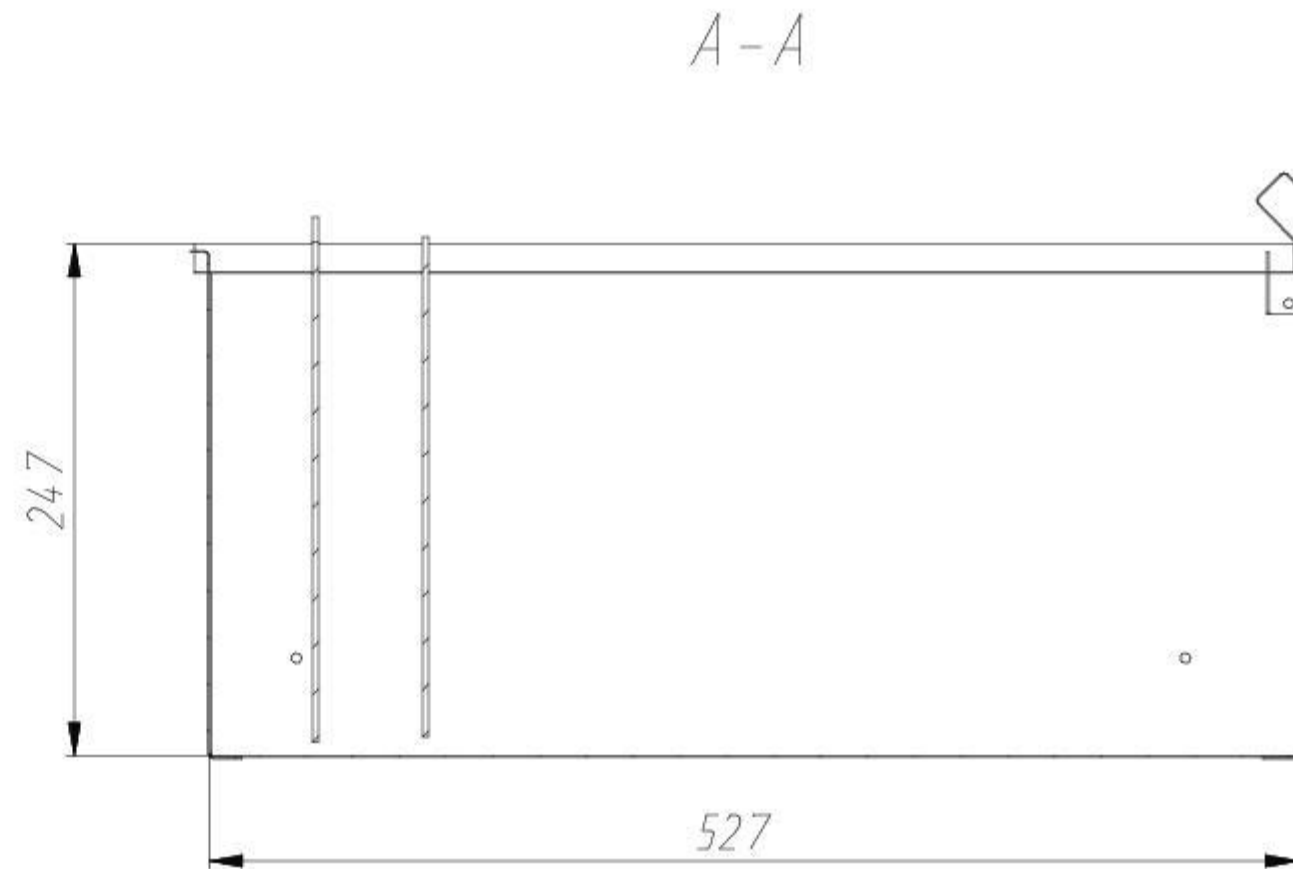
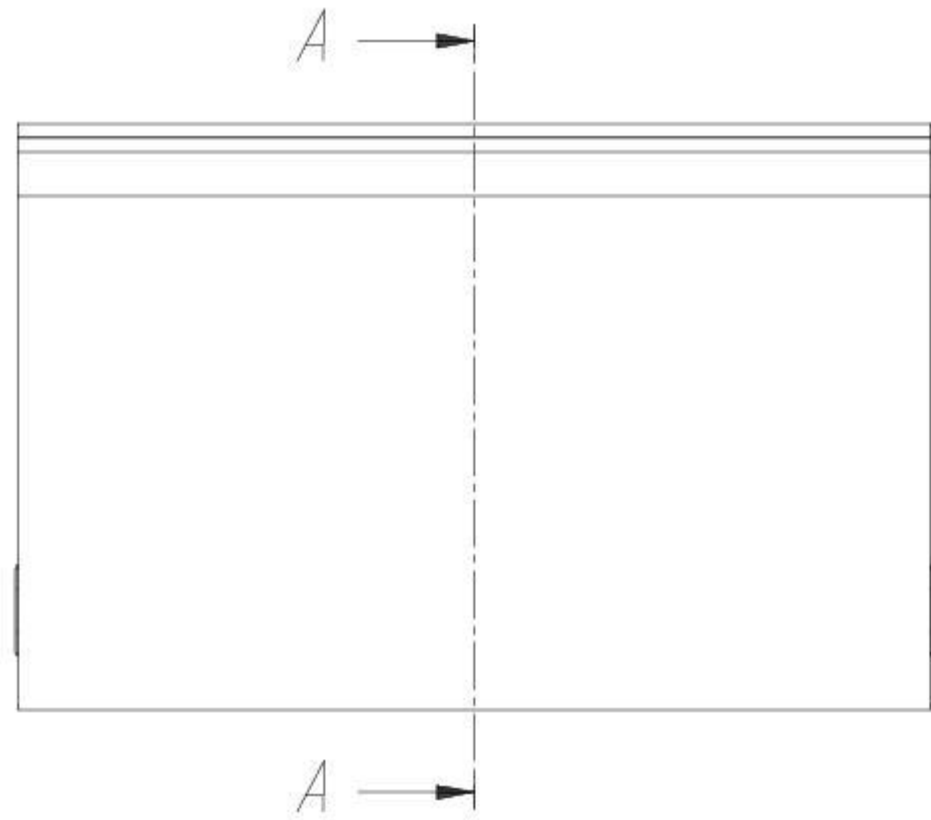

				K4-A4		
	№ докум.			Лист	Масса	Масштаб
Изм.	Лист	№ докум.	Подп.	Дата		
Разраб.						
Проб.						
Т. контр.						
Руковод.						
Н. контр.						
Утв.						
				Лист	Листов	1
				МК		